



**MONTAGEANLEITUNG**

SHAPELINE BLINKLICHT HINTEN WING STYLE

**INSTALLATION INSTRUCTION**

SHAPELINE REAR DIRECTION INDICATOR WING STYLE

**INSTRUCTIONS DE MONTAGE**

SHAPELINE FEU CLIGNOTANT AR WING STYLE

**MONTERINGSANVISNING**

SHAPELINE BLINKLJUS BAK WING STYLE

**MONTAGEHANDLEIDING**

SHAPELINE KNIPPERLICHT ACHTER WING STYLE

**INSTRUCCIONES DE MONTAJE**

SHAPELINE LUZ INTERMITENTE TRASERA WING STYLE

**ISTRUZIONI DI MONTAGGIO**

SHAPELINE INDICATORE DI DIREZIONE POSTERIORE WING STYLE

**ASENNUSOHJE**

SHAPELINE TAKAVILKKUVALO WING STYLE

**DE** Technische Änderungen vorbehalten

**EN** Subject to alteration without notice

**FR** Sous réserve de modifications techniques

**SV** Vi reserverar oss för tekniska ändringar

**NL** Technische wijzigingen voorbehouden

**ES** Reservadas modificaciones técnicas

**IT** Con riserva di modifiche tecniche

**FI** Oikeus teknisiin muutoksiin pidätetään

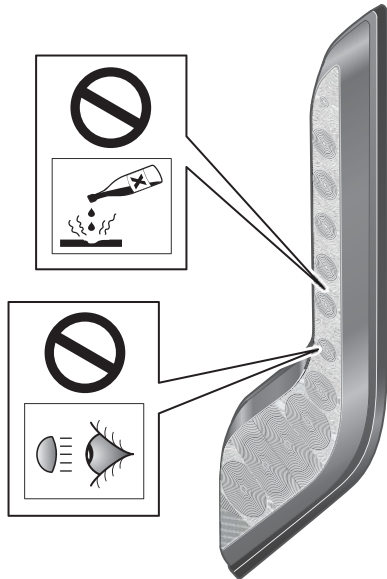
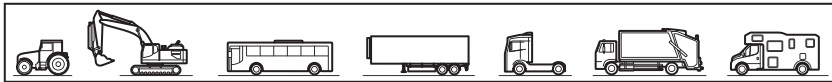

**Produkthaftung**

- Es sind die nationalen Anbau-, Einbau- und Betriebsvorschriften zu beachten und einzuhalten.
- Lesen Sie bitte vor Gebrauch des Gerätes alle beigelegten Anleitungen und Sicherheitshinweise.
- Im Zuge von Produktverbesserung behalten wir uns technische und optische Änderungen vor.
- Verwenden Sie nur die Originalersatzteile bzw. nur Ersatzteile die von HELLA freigegeben sind.
- Bei Fragen oder Einbauproblemen, rufen Sie den HELLA Kundendienst, Großhändler oder wenden Sie sich an Ihre Vertragswerkstatt.

**Product liability**

- National mounting, fitting and operating regulations must be heeded and kept.
- Please read all the instructions and safety notes included before using the device.
- We reserve the right to make technical and optical modifications within the course of product improvement.
- Only use original spare parts or spare parts approved by HELLA.
- If you have any questions or installation problems, call HELLA customer services, your wholesaler or contact your specialist garage.

**Responsabilité produit**

- Les prescriptions nationales en matière de montage et de service doivent être observées et respectées.
- Avant d'utiliser l'appareil lire toutes les instructions de montage et de service fournies ainsi que les conseils de sécurité.
- Dans le cadre de l'amélioration continue de nos produits, nous nous réservons le droit de réaliser des modifications sur les plans technique et optique.
- Utilisez uniquement des pièces d'origine ou des pièces de rechange validées par HELLA.
- Pour tous renseignements ou problèmes de montage, contactez le S.A.V. HELLA, votre distributeur ou votre garage lié par contrat.

**Produktansvar**

- De nationella monterings-, installations- och driftföreskrifterna ska beaktas och följas.
- Läs alla medföljande instruktioner och säkerhetsanvisningar innan du använder apparaten.
- Vi förbehåller oss rätten till tekniska och optiska ändringar som förbättrar produkten.
- Använd endast original reservdelar resp. endast reservdelar som har godkänts av HELLA.
- Om du har frågor eller problem med installationen, ring HELLA kundtjänst, partihandlaren eller vänd dig till din märkesverkstad.

**Productaansprakelijkheid**

- Men dient de nationale aanbouw-, inbouw- en bedrijfsvoorschriften in acht te nemen en na te leven.
- Lees a.u.b. alvorens het apparaat te gebruiken alle bijgevoegde gebruiksaanwijzingen en veiligheidsinstructies door.
- In het kader van de productverbetering behouden wij ons technische en optische veranderingen voor.
- Gebruiksluitende originele reserveonderdelen, die door Hella vrijgegeven zijn.
- Bij vragen of inbouwproblemen dient u de HELLA klantenservice, de groothandel te bellen of u te richten tot de dealerwerkplaats.

**Responsabilidad civil por productos defectuosos**

- Tienen que observarse y cumplirse con las prescripciones nacionales sobre construcciones anexas, de montaje y de funcionamiento
- Rogamos que antes de usar el aparato lean todas las instrucciones y advertencias sobre la seguridad adjuntas.
- En aras de la mejora de los productos, nos reservamos el derecho de hacer modificaciones técnicas y ópticas.
- Use sólo recambios originales o bien sólo recambios autorizados por HELLA.
- Si tiene preguntas que hacer o dificultades en el montaje, llame al Servicio de Atención al Cliente de HELLA, a los mayoristas o diríjase a su taller concesionario.

**Responsabilità per il prodotto**

- Si devono rispettare tutte le normative nazionali di attacco, montaggio e funzionamento.
- Prima di usare l'apparecchio, legga per favore tutte le istruzioni e le avvertenze di sicurezza allegate.
- Nell'ambito del perfezionamento del prodotto, ci riserviamo modifiche tecniche ed estetiche.
- Utilizzate solo pezzi di ricambio originali risp. pezzi autorizzati dalla HELLA.
- In caso di domande o problemi di montaggio, chiami il servizio di assistenza dei clienti della HELLA, il rivenditore o si rivolga alla Sua officina autorizzata.

**Tuotevastuu**

- Kansalliset asennus- ja käyttöohjeet on huomioitava ja niitä on noudatettava.
- Lue ennen laitteen käyttöä kaikki oheistetut käyttö- sekä turvaohjeet.
- Jatkuvasta tuotekehittelystä johtuen pidätämme oikeuden teknisiin ja optisiin muutoksiin.
- Käytä vain alkuperäisiä tai HELLA hyväksymiä varaosia.
- Jos Sinulla on kysymyksiä tai asennusongelmia, soita HELLA-asiakaspalveluun, tukkukauppiaille tai käänny sopimuskorjaamon puoleen.

**Zeichenerklärung**  
**Explanation symbols**  
**Explication des symboles**

**Symbolförklaring**  
**Legenda**  
**Aclaración de símbolos**

**Legenda**  
**Piirroksen selitys**



- DE** Richtig
- EN** Correct
- FR** Correct
- SV** Rätt
- NL** Goed
- ES** Correcto
- IT** Giusto
- FI** Oikein



- DE** Falsch
- EN** Incorrect
- FR** Incorrect
- SV** Fel
- NL** Fout
- ES** Erróneo
- IT** Sbagliato
- FI** Väärin



- DE** Positionspfeil
- EN** Location/Position Arrow
- FR** Flèche de Position
- SV** Positionpil
- NL** Lokatie/Positie pijl
- ES** Flecha de posición
- IT** Freccia di posizione
- FI** Paikannusnuoli



- DE** Bewegungspfeil
- EN** Movement Arrow
- FR** Flèche indiquant sens du mouvement
- SV** Rörelsepil
- NL** Richtingspijl
- ES** Flecha de movimiento
- IT** Freccia di movimento
- FI** Liikesuuntanuoli



- DE** Achtung
- EN** Warning
- FR** Attention
- SV** Varning
- NL** Let op
- ES** Atención
- IT** Attenzione
- FI** Huomio



- DE** Abklemmen
- EN** Disconnect
- FR** Déconnecter
- SV** Koppla los
- NL** Demonteren
- ES** Desconectar
- IT** Staccare
- FI** Irrota



- DE** Verbinden
- EN** Connect
- FR** Connecter
- SV** Ansult
- NL** In elkaar
- ES** Conectar
- IT** Collegare
- FI** Yhdistä



- DE** Siehe
- EN** Look/See
- FR** Voir
- SV** Se
- NL** Kijken naar
- ES** Ver
- IT** Vedere
- FI** Katso

**Lieferumfang**  
**Scope of delivery**  
**Fourniture**

**Leveransomfattning**  
**Leveringsomvang**  
**Alcance de suministro**

**Contenuto della confezione**  
**Toimituksen sisältö**

**2BA 013 333-03**

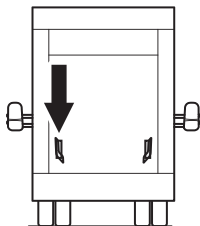
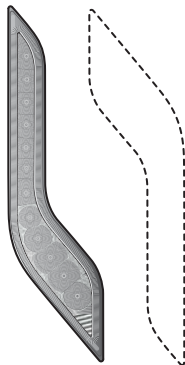

**2BA 013 333-04**

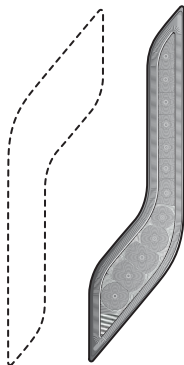
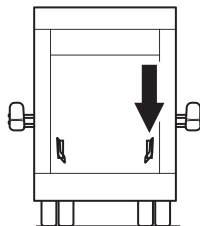



**Zubehör**  
**Accessories**  
**Accessories**

**Tillbehör**  
**Toebehoren**  
**Accessorios**

**Accessori**  
**Lisätarvikkeet**

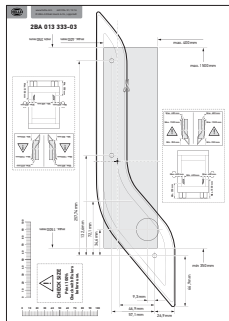

**460 036-12**

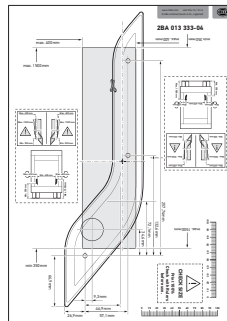

**460 036-13**



**009 492-111 (12V)**



**009 492-011 (24V)**



**3A**

**8JS 711 683 - 821**

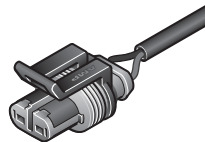

**8JA 746 184-022**

**Benötigte Montagewerkzeuge**  
**Installation tools required**  
**Outillage de montage requis**

**Nödvändiga monteringsverktyg**  
**Benodigde montagewerktuigen**  
**Herramientas de montaje necesarias**

**Attrezzi necessari per il montaggio**  
**Tarvittavat asennustyökalut**



**Ø 5,8 mm**

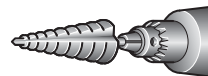

**Ø 26 mm**  
**Ø 30 mm**



**M5**

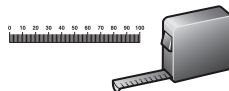

Montage  
Mounting  
Montage Général

Montering  
Montage  
Montaje

Montaggio  
Asennus

ECE-R48  
ECE-R6

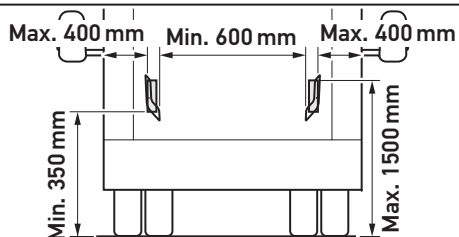
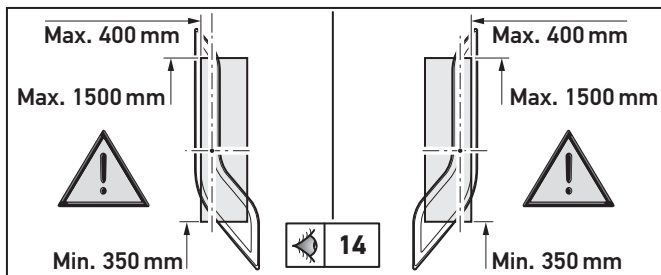

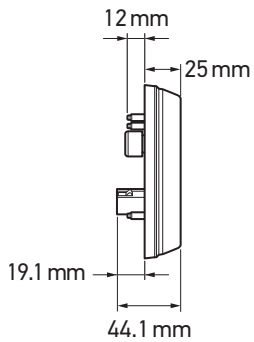
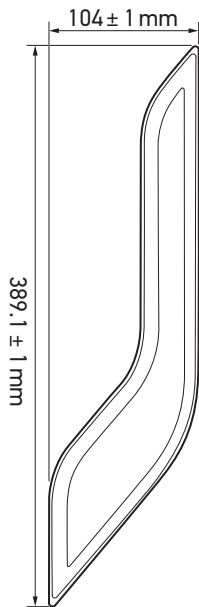

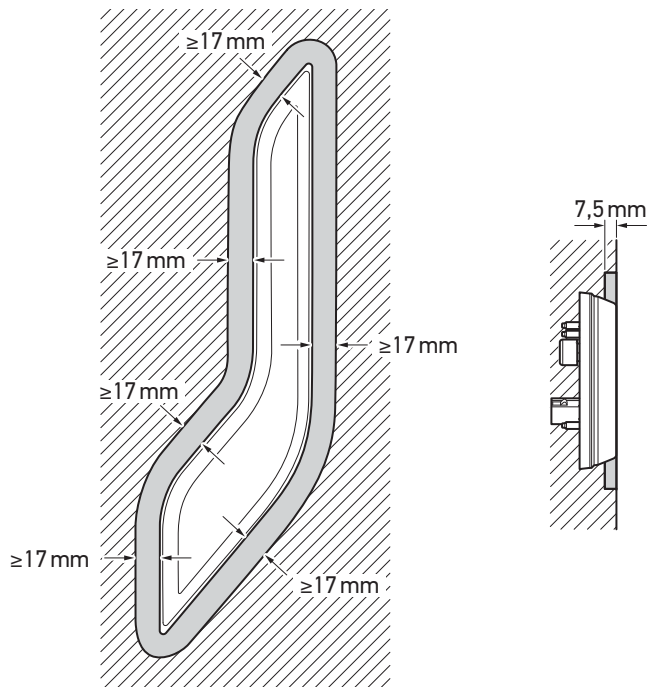

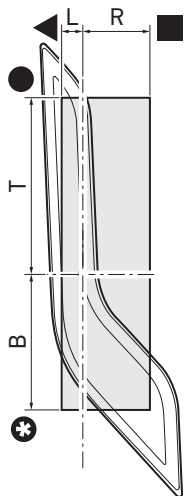

▲ (T) mm	■ (B) mm	* (L) mm	● (R) mm
150	115	18	53

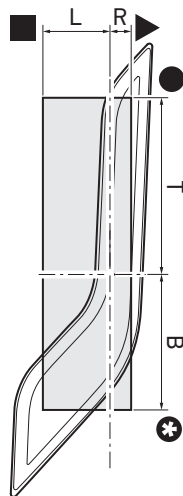

▲ (T) mm	■ (B) mm	* (L) mm	● (R) mm
150	115	53	18

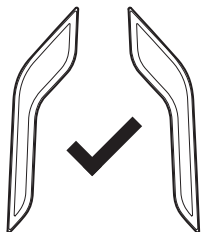
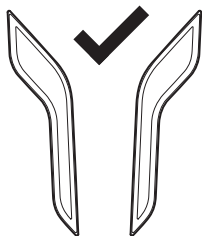
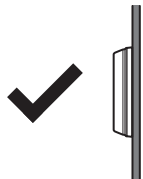
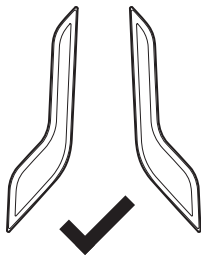
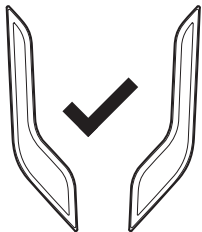

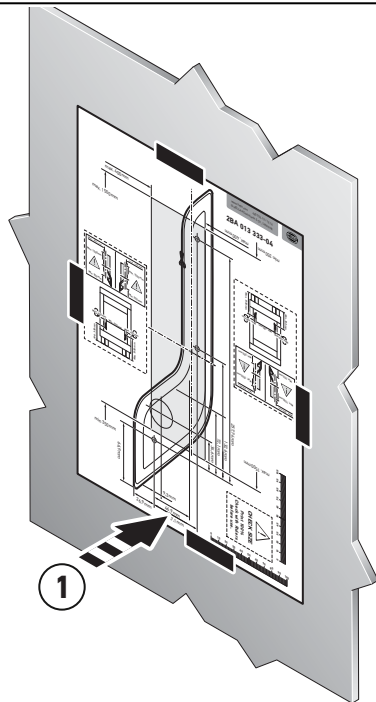
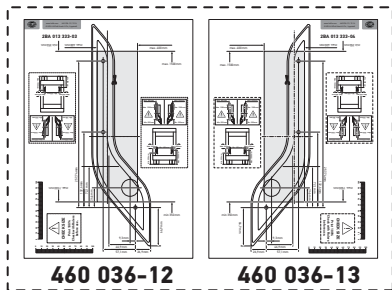
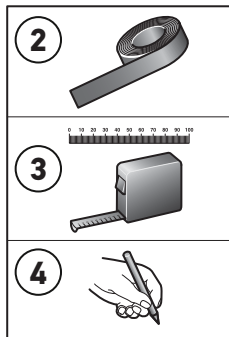



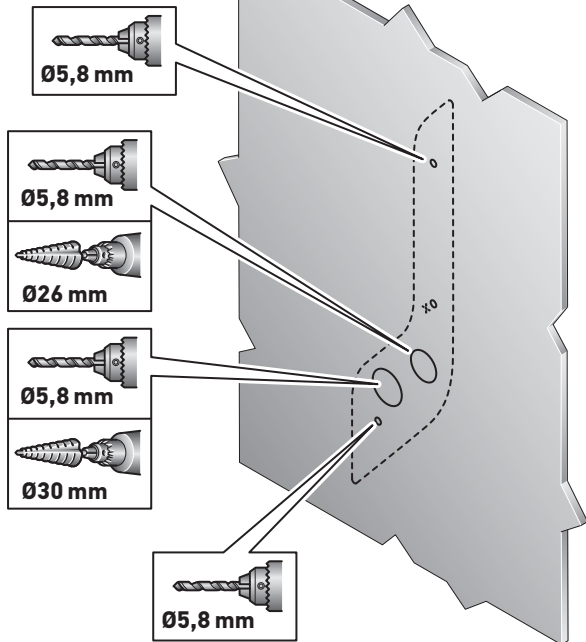
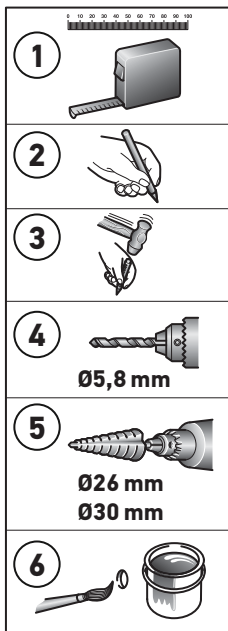



Max.  
3A



M5

max. 1,8 Nm (Plastic)  
max. 2,5 Nm (Metal)

**Elektrischer Anschluss**  
**Electrical connection**  
**Branchement électrique**

**Elektrisk anslutning**  
**Elektrische aansluiting**  
**Conexión eléctrica**

**Collegamento elettrico**  
**Osaluettelo**

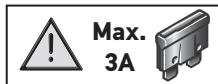
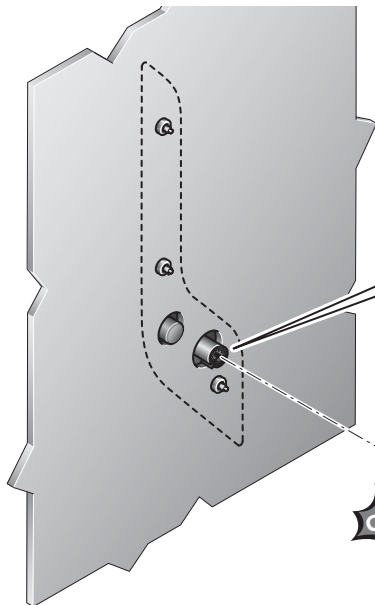

Blinklicht hinten  
Rear Direction Indicator  
Feu clignotant AR  
Blinkljus bak  
Knipperlicht achter  
Luz intermitente trasera  
Indicatore di direzione posteriore  
Takavilkkuvalo

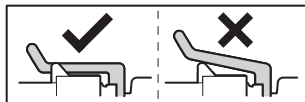

**Elektrischer Anschluss**  
**Electrical connection**  
**Branchement électrique**

**Elektrisk anslutning**  
**Elektrische aansluiting**  
**Conexión eléctrica**

**Collegamento elettrico**  
**Osaluettelo**

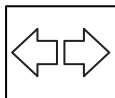

**ISO 13207**

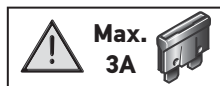
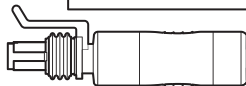
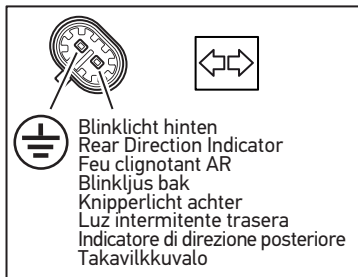
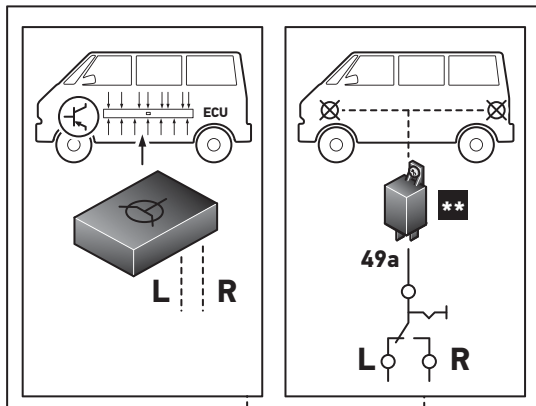
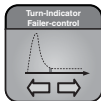

**\*\*** 12V = 009 492-111  
24V = 009 492-011

<b>DE</b> Informationstext	22
<b>EN</b> Information Text	22
<b>FR</b> Texte d'information	22
<b>SV</b> Informationstext	23
<b>NL</b> Informatie tekst	23
<b>ES</b> Texto informativo	23
<b>IT</b> Informazioni	24
<b>FI</b> Ohjetekstit	24

**DE TECHNISCHE DATEN**

Nennspannung	Spannungsbereich	Eingangswerte	Zulässige Umgebungstemperatur	Schutzklasse
12 V	9V -16 V	< 3,9 W < 8W	-40° C bis +60° C	IP 6K7, IP X9K
24 V	18V -32 V			

**Der Betrieb der Leuchte mit Wechselspannung oder getakteter Gleichspannung ist nicht zulässig!**

**EN TECHNICAL DATA**

Nominal voltage	Range of voltage	Input values	Admissible ambient temperature	Class of protection
12 V	9V -16 V	< 3,9 W < 8W	-40°C up to +60°C	IP 6K7, IP X9K
24 V	18V -32 V			

**Operation of the light using alternating voltage or clocked direct voltage is not permitted!**

**FR DOCUMENT TECHNIQUE**

Tension nominale	Valeurs d'entrée	Valeurs d'entrée	Température ambiante admissible	Classe de protection
12 V	9V -16 V	< 3,9 W < 8W	-40°C à +60°C	IP 6K7, IP X9K
24 V	18V -32 V			

**Le fonctionnement du feu avec une tension alternative ou une tension continue cadencée n'est pas admis!**

**SV** TEKNISKA DATA

Märk-spänning	Spänning-sområde	Ingångsvärden	Tillåten omgivnings-temperatur	Skyddsklass
12V	9V -16V	< 3,9 W < 8W	-40°C upp till +60°C	IP 6K7, IP X9K
24V	18V -32V			

**Lampan får inte användas med växelspanning eller taktad likspanning!**

**NL** TECHNISCHE GEGEVENS

Nominale spanning	Spannings-bereik	Ingangswaarden	Toegestane omgevings-temperatuur	Beschermklasse
12V	9V -16V	< 3,9 W < 8W	-40°C tot +60°C	IP 6K7, IP X9K
24V	18V -32V			

**Het gebruik van de lamp met wisselspanning of getacte gelijkspanning is niet toegestaan!**

**ES** DATOS TÉCNICOS

Tensión nominal	Margen de tensión	Valores de entrada	Temperatura ambiente admisible	Clase de protección
12V	9V -16V	< 3,9 W < 8W	-40°C hasta +60°C	IP 6K7, IP X9K
24V	18V -32V			

**¡No es admisible el funcionamiento de las luces con corriente alterna o corriente continua sincronizada!**

**IT DATI TECNICI**

Tensione nominale	Intervallo di tensione	Valori di ingresso	Temperatura ambiente ammessa	Categoria di protezione
12V	9V -16V	<3,9W <8W	da -40°C a +60°C	IP 6K7, IP X9K
24V	18V -32V			

**Non è consentito attivare i fanali con tensione alternata o tensione continua ciclica!**

**FI TEKNISET TIEDOT**

Nimellis-jännite	Jännitealue	Tuloarvot	Sallittu ympäristölämpötila	Kotelointiluokka
12V	9V -16V	<3,9W <8W	-40°C ... +60°C	IP 6K7, IP X9K
24V	18V -32V			

**Valoa ei saa käyttää vaihtojännitteellä eikä tahdistetulla tasajännitteellä!**



**DE** Beleuchtungsanlage auf einwandfreie Funktion hin prüfen

**EN** Check that the lighting system is working perfectly

**FR** Contrôler le bon fonctionnement de l'installation d'éclairage

**SV** Kontrollera att ljussystemet fungerar felfritt

**NL** Controleer of de verlichting goed functioneert

**ES** Comprobar que el sistema de iluminación funciona impecablemente

**IT** Controllare la perfetta funzionalità dell'impianto di illuminazione

**FI** Tarkasta valaistusjärjestelmän toiminta



**HELLA KGaA Hueck & Co.**

Rixbecker Straße 75  
59552 Lippstadt / Germany

[www.hella.com](http://www.hella.com)

© HELLA KGaA Hueck & Co., Lippstadt  
460 035-60 / 04.17