

x 2

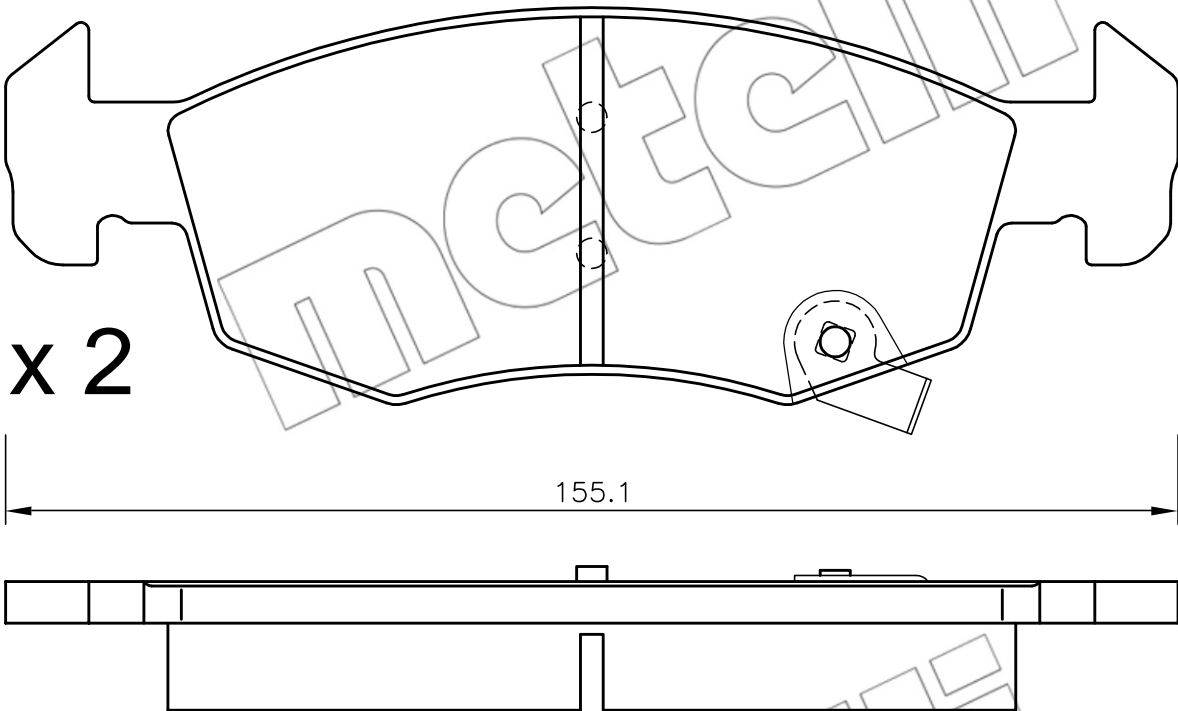

x 2

155.1

52.5

17